

(3;2)

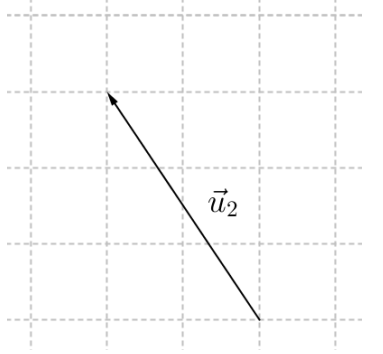

(-2;3)

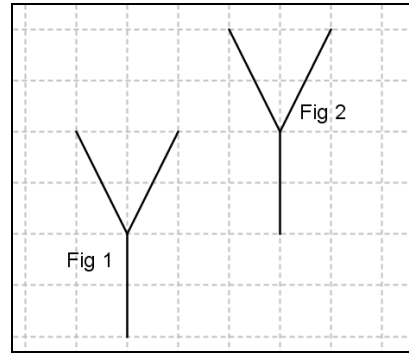
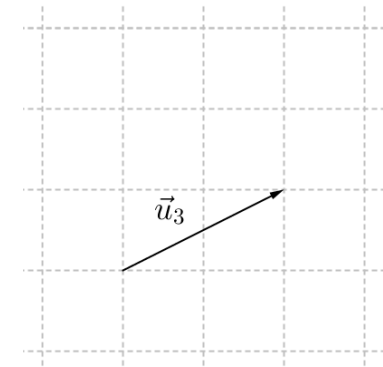
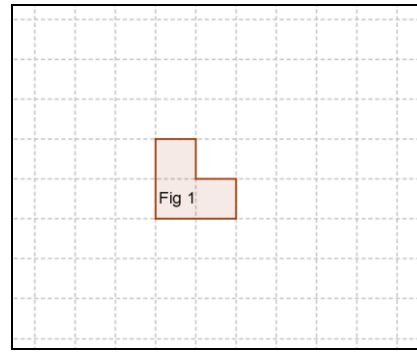

(2;1)

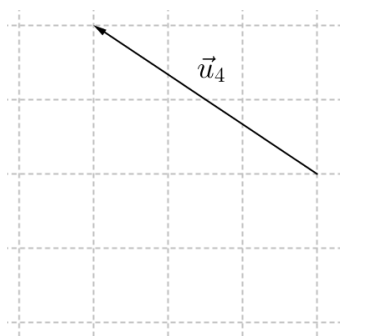
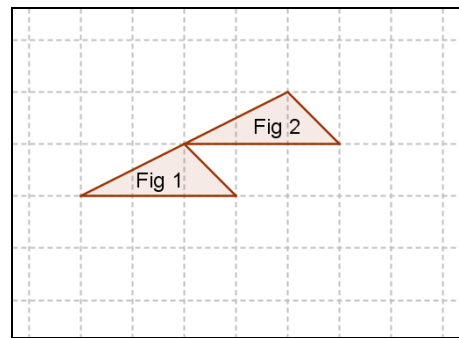

(-3;...)

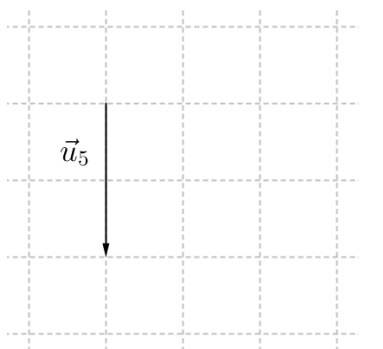
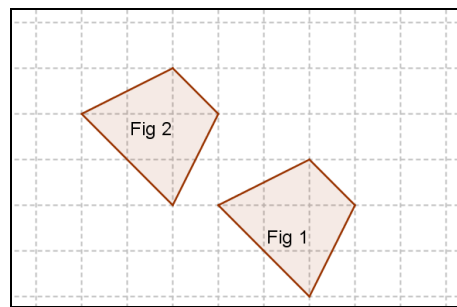

(0;-2)

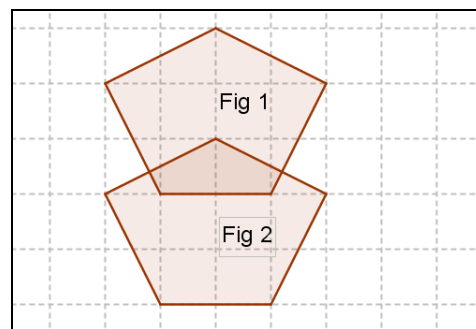

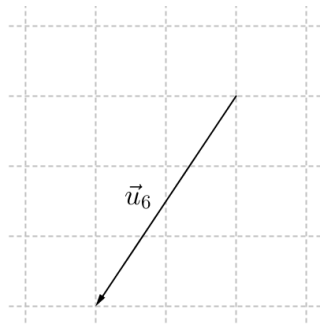

$(-2;-3)$

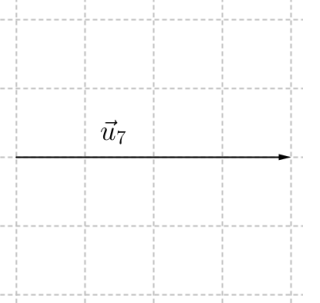
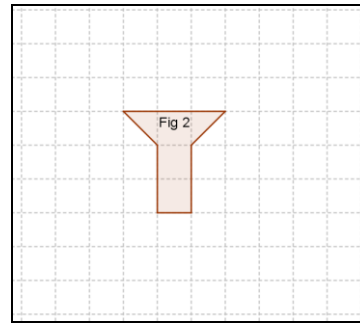

$(...;0)$

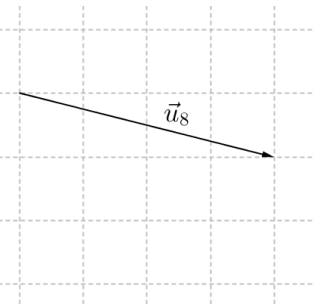
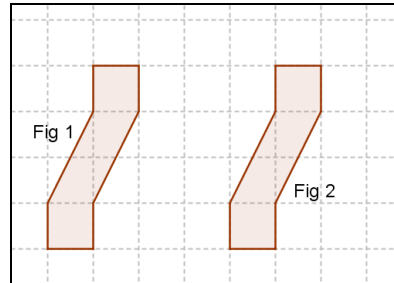

$(4;-1)$

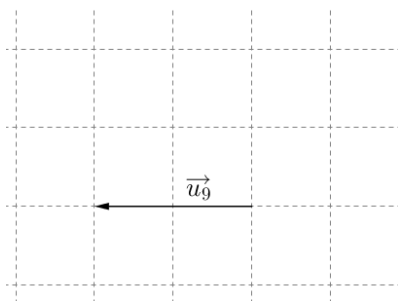
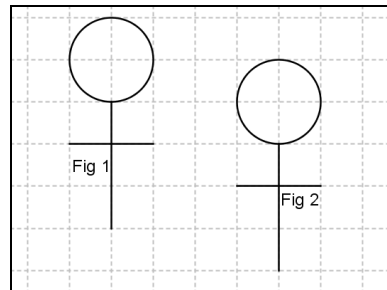

$(-2;0)$

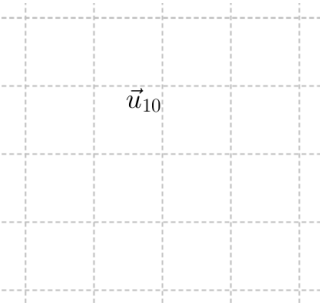
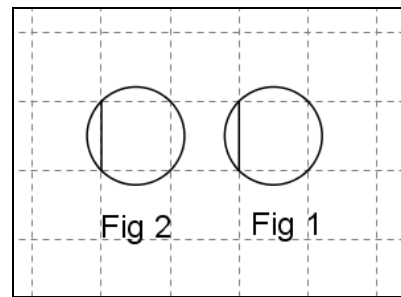

$(-1;2)$

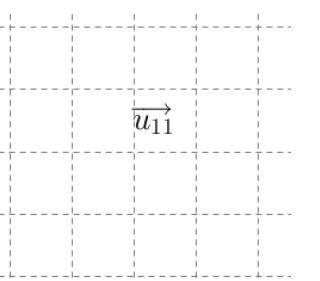
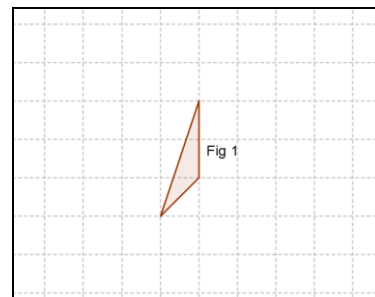

$(...;...)$

